



EQUIPAGGIAMENTI  
TECNICI  
LAVAGGIO

30.2840.00  
PISTOLA RL 82+ARS350 B  
GUN RL 82+ARS350 B

I  
GB

1

14/01/10

CARATTERISTICHE TECNICHE  
SPECIFICATIONS

- PRESSIONE NOMINALE RATED PRESSURE	125 bar – 12.5 MPa (1850 psi)
- PRESSIONE CONSENTITA PERMISSIBLE PRESSURE	140 bar – 14 MPa (2030 psi)
- PORTATA MASSIMA MAX FLOW RATE	80 l/min (21 USG p.m.)
- TEMPERATURA MASSIMA MAX WORKING TEMPERATURE	160° C (320 °F)

MISURE D'INGOMBRO  
OVERALL DIMENSIONS

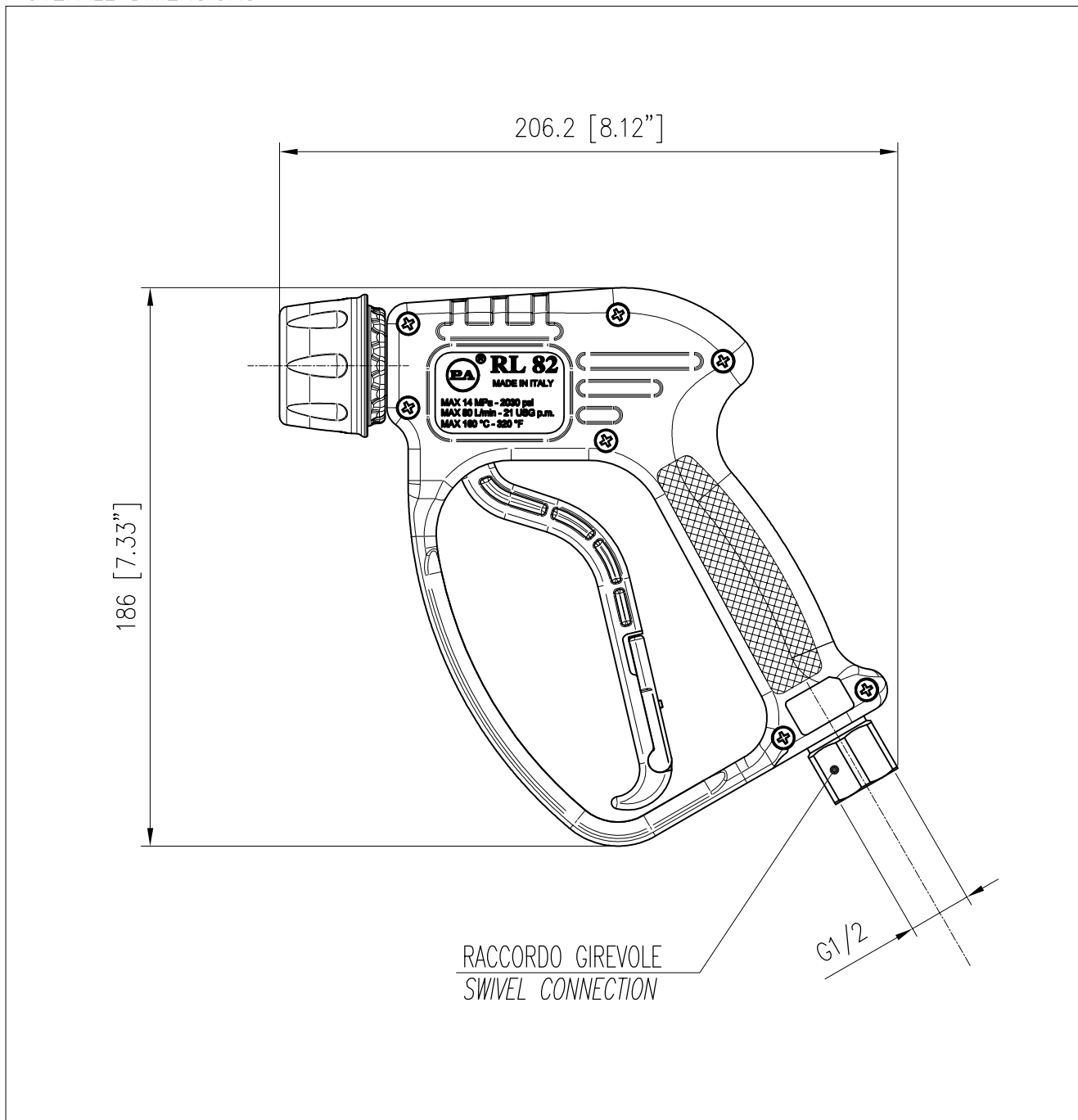



EQUIPAGGIAMENTI  
TECNICI  
LAVAGGIO

30.2860.00  
PISTOLA RL 82+ARS178 B  
GUN RL 82+ARS178 B

I

GB

1

14/01/10

CARATTERISTICHE TECNICHE  
SPECIFICATIONS

- PRESSIONE NOMINALE RATED PRESSURE	125 bar – 12.5 MPa (1850 psi)
- PRESSIONE CONSENTITA PERMISSIBLE PRESSURE	140 bar – 14 MPa (2030 psi)
- PORTATA MASSIMA MAX FLOW RATE	80 l/min (21 USG p.m.)
- TEMPERATURA MASSIMA MAX WORKING TEMPERATURE	160° C (320 °F)

MISURE D'INGOMBRO  
OVERALL DIMENSIONS

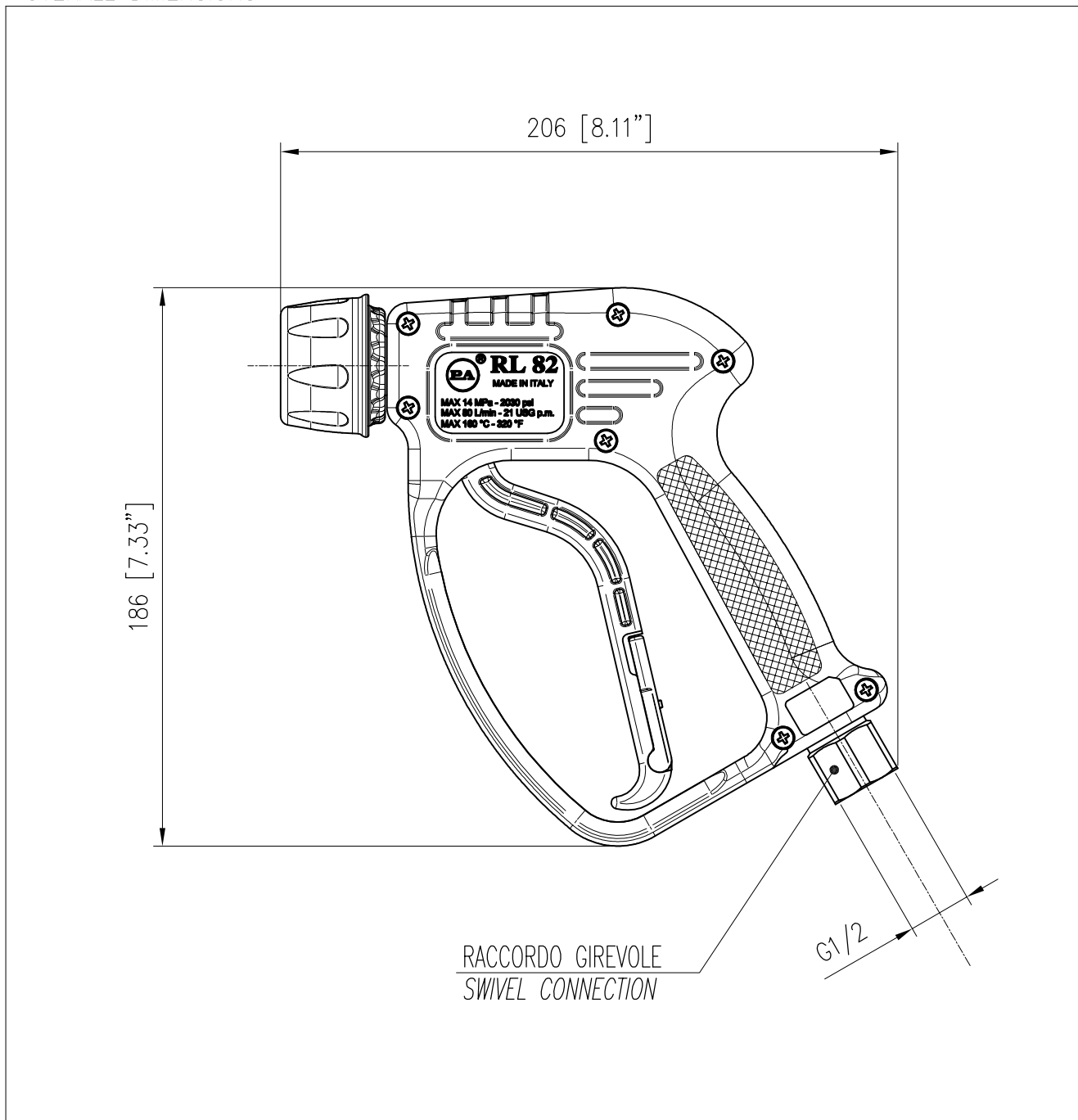



EQUIPAGGIAMENTI  
TECNICI  
LAVAGGIO

30.2880.00  
PISTOLA RL 82+ARS25 B  
GUN RL 82+ARS25 B

I

GB

1

14/01/10

CARATTERISTICHE TECNICHE  
SPECIFICATIONS

- PRESSIONE NOMINALE RATED PRESSURE	125 bar – 12.5 MPa (1850 psi)
- PRESSIONE CONSENTITA PERMISSIBLE PRESSURE	140 bar – 14 MPa (2030 psi)
- PORTATA MASSIMA MAX FLOW RATE	80 l/min (21 USG p.m.)
- TEMPERATURA MASSIMA MAX WORKING TEMPERATURE	160° C (320 °F)

MISURE D'INGOMBRO  
OVERALL DIMENSIONS

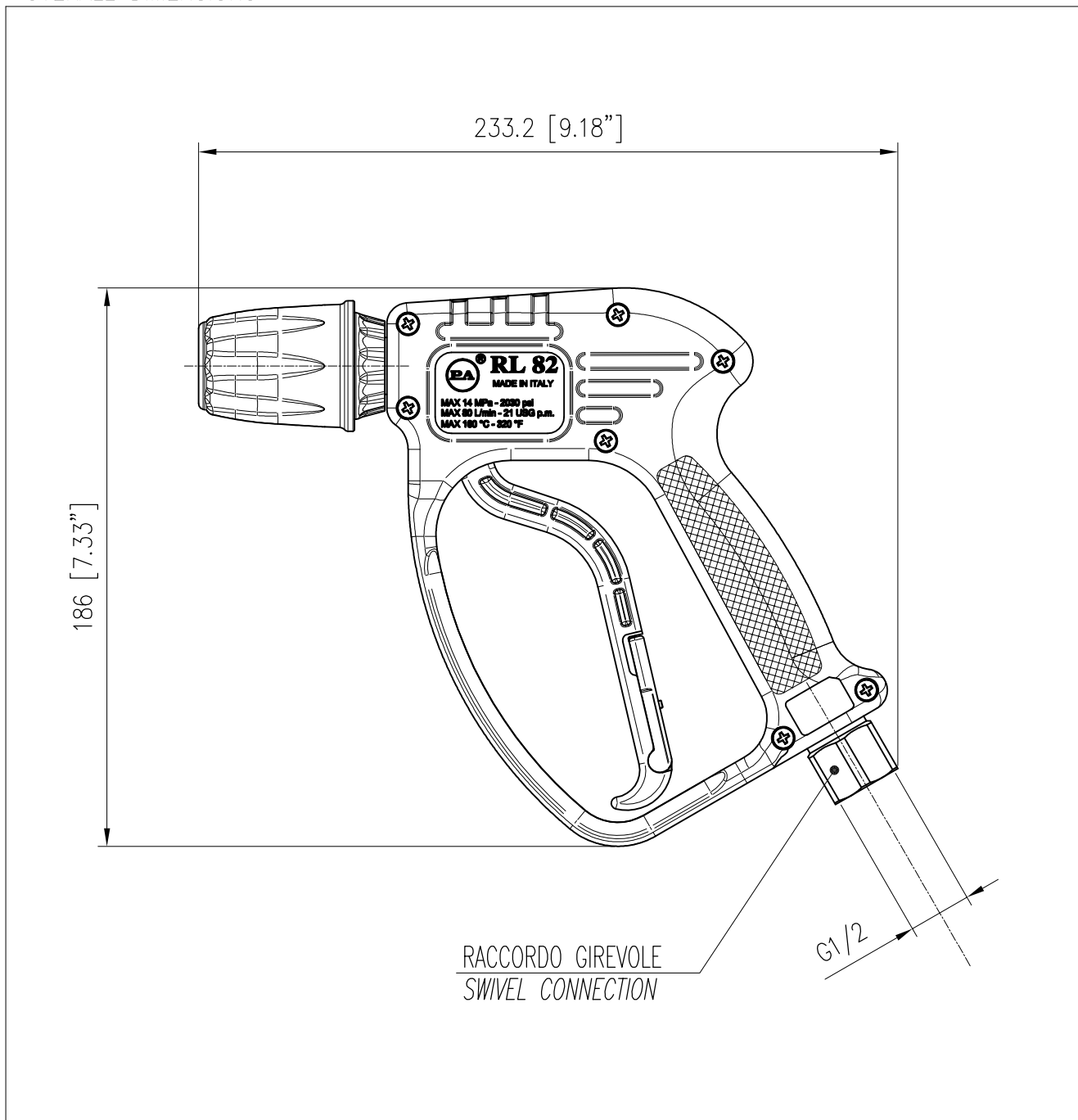



P.A. S.p.A.

Via Milano, 13  
42048 Rubiera, Reggio Emilia - Italy

Tel +39.0522.623611  
Fax +39.0522.629600

info@pa-etl.it

[www.pa-etl.it](http://www.pa-etl.it)



COMPANY WITH QUALITY MANAGEMENT  
SYSTEM CERTIFIED BY DNV  
= ISO 9001 =